

Product information

## Ultrasonic metal welding system Telso<sup>®</sup>Terminal TT7



# Telso®Terminal TT7: the digitalized, innovative ultrasonic metal welding system

The new Telso®Terminal TT7, Telsonic revolutionizes ultrasonic metal welding through digitalization for full process control and introduces a new generation of PowerWheel® technology. All optimizations as per market requirements have been incorporated into the new metal welding system. That's why the TT7 is even more versatile, efficient and user-friendly.

## Application areas

The new Telso®Terminal TT7 ultrasonic metal welding system is versatile and can be used for various applications, including cable assembly and battery production. Among other things, its applications include HV cables, battery terminals and cell connectors, which are welded in a wide variety of designs. The new high-performance system allows metal welding for cable cross-sections up to over 200 mm<sup>2</sup>. The modular design of the TT7 enables quick changeover to other applications. The Telso®Terminal TT7 also features standardized interfaces for digital networking and easy integration into production systems.

## Typical applications

- » High-voltage cable connections
- » Busbar applications
- » Battery cell connectors
- » Battery connection contacts
- » Connection terminals (straight and angled, 3D terminals)
- » Plug contacts, cable lugs
- » Tubular cable lugs
- » Short cables and terminals with two welds
- » Stranded braided wires
- » Stranded wire splicing (special applications)

## Application examples



3D terminal



Tubular cable lug with ultrasonic crimp welding



Aluminum busbar



Multiple quick-change systems reduce application and tool changeovers to just a few minutes

## Highlights

### OUTSTANDING PROCESS CONTROL

The TT7 revolutionizes ultrasonic metal welding through digitalization for full process control. The comprehensive control mechanisms ensure continuous monitoring of the welding process. Power supply interruptions are also detected immediately, thereby preventing faulty production. This ensures a smooth welding process with accurate results.

### WIDE RANGE OF APPLICATIONS, LARGE CROSS SECTIONS

The TT7 is versatile for various applications in cable assembly and battery production. Current applications include HV cables, cell connectors and battery terminals. The new high-end system allows metal welding for cable cross-sections up to over 200mm<sup>2</sup>.

### SHORT CYCLE TIME, HIGH PRODUCTIVITY

The innovative metal welding system enables an ultra-short cycle time of only 15 seconds, thereby ensuring maximum productivity.

### NEW DESIGN FOR THE POWERWHEEL®

The Telso®Terminal TT7 works with the latest version of the proven PowerWheel® welding technology. The PowerWheel® torsional welding technology ensures maximum reliability and optimum

process control. Telsonic has further developed the innovative technology for the TT7. For example, a tool changeover on the TT7 takes less than five minutes thanks to the quick-change system.

### EASY INTEGRATION INTO PRODUCTION LINES

The modular design of the TT7 enables quick changeover to other applications. The Telso®Terminal TT7 also features standardized interfaces for digital networking and easy integration into production systems.

### TELSONIC®FLEX DIGITALIZATION

The Telso®Flex operating software extended for the TT7 facilitates the efficient production, monitoring and logging of applications. The intuitive user interface displays only the information relevant to the user. Production data and values from various monitored sensors are available for digitalization processes.



Short cables, welded on both sides



High-voltage cable set with plug contacts



High-voltage cables with plug contacts

# Modern, innovative system design



Andon signal lamp informs about the status of the machine

Informative 21.5" touch screen

Ergonomic, bright work area for a consistent, good view of the welding process

Installation space for integrating optionally available devices, such as a water cooling system and a particle extraction system

Quick release fasteners for good accessibility

Mounting options for peripheral devices such as label printer, keyboard, and scanner

# PowerWheel®

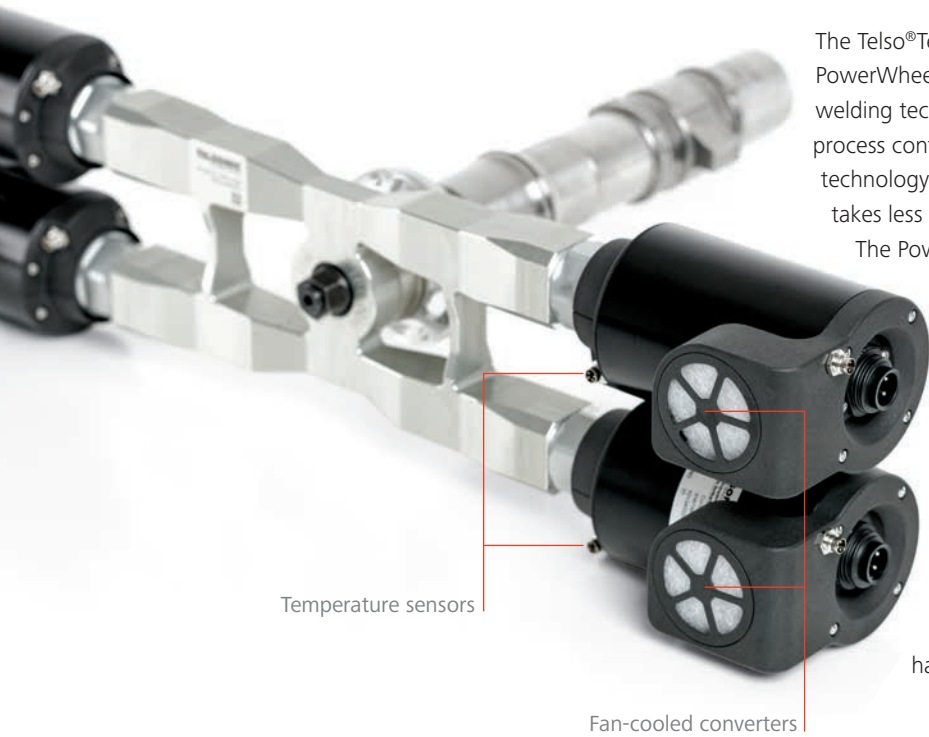

The Telso®Terminal TT7 works with the latest version of the proven PowerWheel® welding technology. The PowerWheel® torsional welding technology ensures maximum reliability and optimum process control. Telsonic has completely revised the innovative technology for the TT7. For example, a tool changeover on the TT7 takes less than five minutes thanks to the quick-change system.

The PowerWheel® welding technology uses an innovative oscillation behavior of the sonotrode, which is excited by a torsional oscillator. The welding movement takes place in a pendulum movement directly into the welding. This ensures that the maximum amplitude is always in the centre of the welding surface and the energy is applied to the welding zone in a targeted manner. As with conventional ultrasonic welding, the PowerWheel® system can weld all non-ferrous metals and combinations.

For even better efficiency, the PowerWheel® sonotrode has up to four welding surfaces.

## Quick-change system

The self-centering positioning (Poka Yoke) of the PowerWheel® sonotrode eliminates sources of error and greatly reduces adjustment work. The welding amplitude can be optimally adjusted to the application via a booster.



## Standardized, modular, process-safe

The Telso®Terminal TT7 metal welding system is designed as a modular system. Standardization allows the same type of system to be used for a wide range of applications. If a few modules, such as the parts positioning or the sonotrode, are exchanged, the system can be reconfigured for another application in a few minutes.

### Standard modules

- Telso®Terminal TT7 system with controller and ultrasonic generator
- The new PowerWheel® vibration system, with quick-change system and booster ratio
- Terminal clamping, with horizontal and vertical movement direction
- Anvil with quick-change system and indexing
- Fan-cooled converters
- QR and barcode reader



Part positioning nest

### Optional functions

- Part positioning nest
- Cable positioning with insertion detection
- Cable clamping for single and multiple lines
- Wire cutter to directly destroy incorrect weldings
- Connection for an external bad parts container, for monitored disposal
- Damping system for vibration-sensitive terminals
- Integrated debris extraction system with sonotrode cooling
- Liquid temperature control system for the sonotrode and holding-down jaws
- Temperature monitoring of the converters
- Status lamp
- Keypad
- Quality monitoring software package
- Software package for guided application changeover
- Software interfaces via OPC-UA and for peripheral devices



Cable positioning



Automatic cable clamping



Keyboard and 2D barcode scanner



Illuminated welding room



Wire cutter

## Produce quickly and cleanly

Energy-intensive welding heats up the tools, which leads to longer welding intervals and fluctuating weld quality. Cooling systems are used to increase productivity and maintain consistent welding quality.

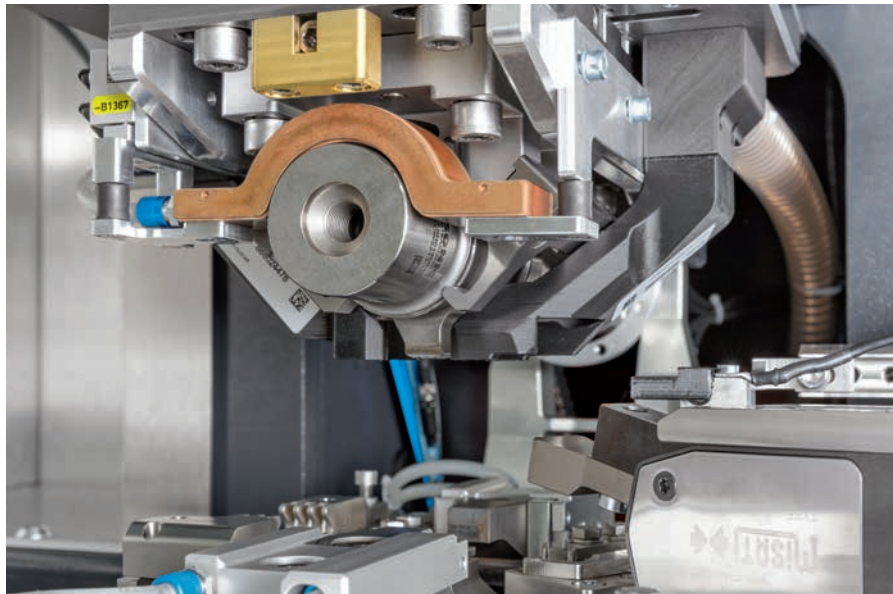

The sonotrode and the gathers are kept in the required temperature range using the liquid circuit

### Temperature controlled tools

The Telso®Terminal TT7 uses a liquid temperature control system and thus solves the problem of depending on expensive compressed air cooling. The liquid temperature control system ensures a constant temperature of the tools before and during welding.

The temperature setpoint is conveniently specified in the Telso®Flex software. If the tool temperature is outside the limits after all, production is prevented and the operator is informed.

The cooling process protects the tools and ensures a stable welding process with consistent product quality.

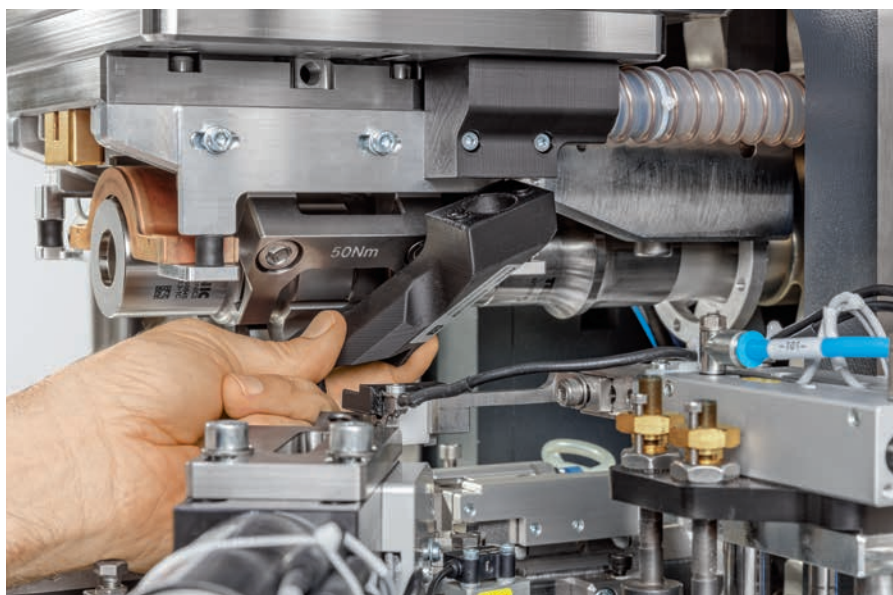

The extraction nozzles are designed for the application and can be replaced within seconds

### Clean welding area

Welding produces fine metal debris that spread in the welding area. If these particles are not removed regularly, they can influence the process over time and, in the worst case, also block mechanical guides. The innovative debris extraction system removes most metal particles at the point of origin and discharges them. This reduces maintenance work and increases system efficiency.

In addition, unhealthy byproducts, e.g. from PVC insulations, are also extracted and the air flow cools the tools.



Forward-looking control technology with a user-friendly interface

## Telso®Flex – the innovative control technology

Efficient production, monitoring and logging of applications requires well thought-out control software. That is why the Telso®Terminal TT7 is equipped with the advanced Telso®Flex operating software. On the intuitive user interface, the user has all relevant information at a glance. Production data and values from various monitored sensors are available for digitalization processes. The new, additional functions make operation even easier. Operator errors during application changeovers and maintenance are minimized and all tool changeovers are logged.

### Highlights from Telso®Flex

- New operators become productive sooner due to step-by-step operator guidance with texts and pictures of the parts to be joined
- Additional sensors detect contact parts that are inserted at an angle and deviate greatly in height as well as cables that are inserted incorrectly and deviate greatly in diameter
- The automatic self-test of the system ensures stable production conditions and timely fault detection.
- The parts to be joined are recorded in detail and with images in the material database. Thus, material changes are also documented and traceable.
- The application-specific step-by-step instructions and test steps prevent errors during application changeovers
- Useful functions are available for maintenance and servicing, which reduce unproductive time
- Remote access via the standardized VPN protocol is available for in-house monitoring and support
- Unauthorized changes are prevented with user and rights management for three user groups



# Increase productivity

Productivity depends on various factors. The Telso®Flex offers various functions that ensure better quality and equally shorter process times. This begins with the design of the application for process-safe parameters. During production, the Telso®Flex enables continuous quality monitoring. The system detects trends that can be used to quickly detect and prevent possible production errors. Operators also have the option of adjusting the batch size of the packaging unit when producing large batches. In addition, the software offers them valuable information and topic-related assistance, which reduces unproductive time for maintenance and service to a minimum.

## All information at a glance



The loaded application is displayed with a description and image.

The specification for the number of parts to be produced and the size of the packaging unit are displayed.

The welding results and their limits are shown as values and as colored bars.  
■ = safely within the limits  
■ = close to the limits  
■ = outside the limits

The welding curves for power, force, distance and frequency are displayed, optionally also with the limit values and with additional process phases.

Quantity of produced parts, categorized into good and bad parts, as well as batch and lot counter.

All relevant information is displayed on the 21.5" touch screen

## User-friendly and networked

As a system operator, you benefit from numerous advantages with the TT7. These include step-by-step instructions for operators and during application changeovers, outstanding process control, standardized interfaces for digital networking and easy integration into automation systems.

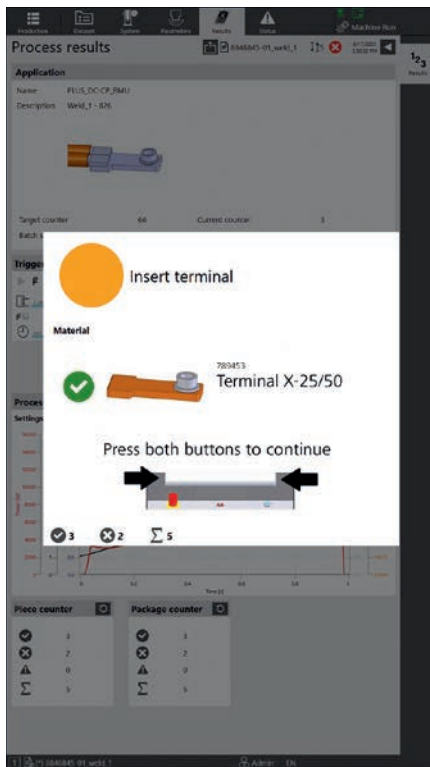

Step-by-step instructions reduce training effort for new operators.

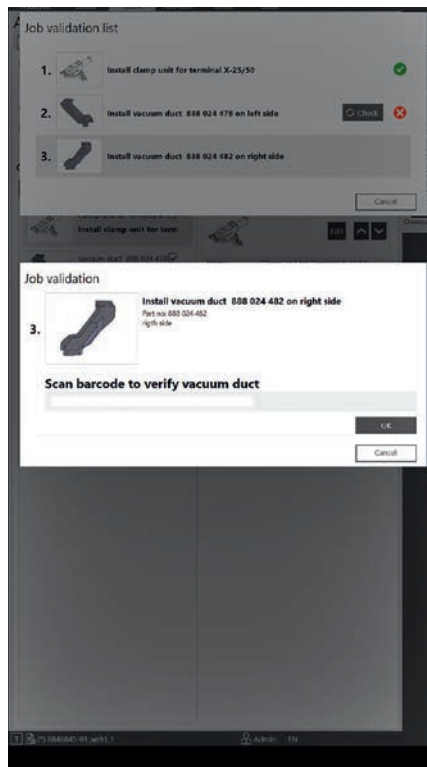

With the guided application changeover, instructions can be given, values can be checked and questions can be asked.

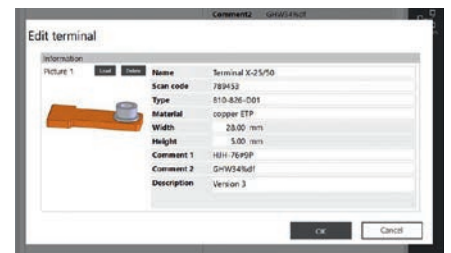
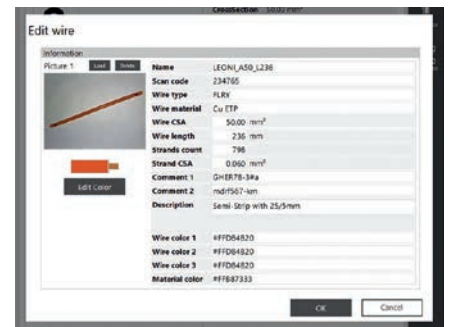

The cable and terminal database records the joining parts with numerous details and images. This supports operators and also makes it easy to document material changes.

## Easy integration into Manufacturing Execution Systems (MES)

The Telso®Terminal TT7 can be connected directly to the customers' MES (Manufacturing Execution System), which increases process reliability and facilitates quality assurance. The Telso®CON interface provides a flexible solution for the integration of the Telso®Terminal TT7 via OPC-UA. Production data remains transparent at all times. This allows production orders with all technical parameters to be transferred automatically. All parameters and results can be shared via the network and used to optimize production control. Users can access real-time production data and welding results at any time and save data to network drives or other storage media – to ensure traceability, for example – once it has been processed for the specific purpose it is to serve.

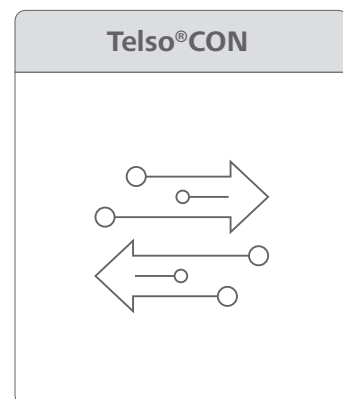



## Remote access

Would you like to keep an eye on the progress of the current production batch or the plant status at all times? The standardized and encrypted VPN protocol gives you full access to the user interface. This allows you to remotely check the system status and support the operators via remote access.

## Printing labels

Users have the option to print labels directly using standard industrial printers. They can also set when labels are to be printed and the information they contain. Production data as well as production order and application information can be printed.

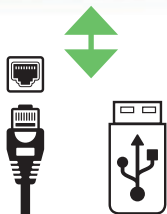

## Traceability and control

To ensure traceability and quality control, all welds are logged – including all parameters and results. The log can be stored locally on a USB stick, network or FTP drive and can therefore be continuously updated.

If customers need support, they can export a service snapshot and have it analyzed by Telsonic. As such, Telsonic offers fast and efficient support – worldwide.

**Your Contact**

[www.telsonic.com](http://www.telsonic.com)



This brochure may show parts which are available as options rather than as part of the standard equipment. In some cases, safety covers have been opened or removed in order to show machine details more clearly. Subject to changes to dimensions, design and equipment. See separate data sheets for technical data.

Certified to ISO 9001 & 14001